

DENON[®]

DCD-600NE

COMPACT DISC PLAYER

Owner's Manual

[Front panel](#)[Display](#)[Rear panel](#)[Remote](#)[Index](#)

Accessories	4
Inserting the batteries	5
Operating range of the remote control unit	5
Features	6
High quality sound	6
High performance	6
Part names and functions	7
Front panel	7
Display	9
Rear panel	10
Remote control unit	11

Connections

Connecting an amplifier	18
Connecting to a device with digital audio input connectors	19
Connecting the timer device	20
Connecting the power cord	21

Playback

Basic operation	23
Turning the power on	23
Switching the power to standby	23
Switching the display's brightness	24
Switching the Pure Direct mode	24
Playing CDs	25
Playing CDs	25
Playing tracks in a specific order (Program playback)	27
Playing DATA CDs	28
Playing files	29
Using the timer play function	31



Settings

Setting the Auto Standby mode	32
-------------------------------	----

Tips

Tips	34
------	----

Troubleshooting	35
------------------------	-----------

Power does not turn on / Power is turned off	36
--	----

Operations cannot be performed through the remote control unit	37
--	----

Display on this unit shows nothing	37
------------------------------------	----

No sound comes out	38
--------------------	----

Sound is interrupted or noise occurs	38
--------------------------------------	----

Cannot playback Discs	39
-----------------------	----

Appendix

Playing back Discs	40
---------------------------	-----------

Files	40
-------	----

Playback order of files	42
--------------------------------	-----------

About folders and files	42
--------------------------------	-----------

Cautions on using media	43
--------------------------------	-----------

Loading discs	43
---------------	----

How to handle media	44
---------------------	----

Cleaning discs	44
----------------	----

Explanation of terms	45
-----------------------------	-----------

Trademark information	46
------------------------------	-----------

Specifications	47
-----------------------	-----------





Index	50
--------------	-----------

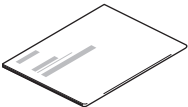
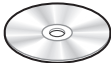

Thank you for purchasing this Denon product. To ensure proper operation, please read this owner's manual carefully before using the product. After reading this manual, be sure to keep it for future reference.

Accessories

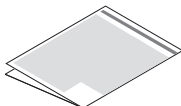
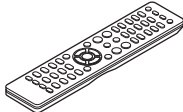
Check that the following parts are supplied with the product.

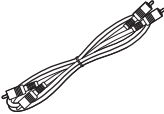
 Quick Start Guide	 CD-ROM (Owner's Manual)	 Safety Instructions	 Cautions on Using Batteries
 Remote control unit (RC-1234)	 R03/AAA batteries	 Audio cable	



Inserting the batteries

- 1 Remove the rear lid in the direction of the arrow and remove it.



- 2 Insert two batteries correctly into the battery compartment as indicated.

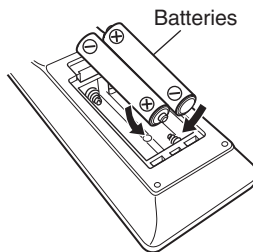

- 3 Put the rear cover back on.

NOTE

- To prevent damage or leakage of battery fluid:
 - Do not use a new battery together with an old one.
 - Do not use two different types of batteries.
- Remove the batteries from the remote control unit if it will not be in use for long periods.
- If the battery fluid should leak, carefully wipe the fluid off the inside of the battery compartment and insert new batteries.

Operating range of the remote control unit

Point the remote control unit at the remote sensor when operating it.

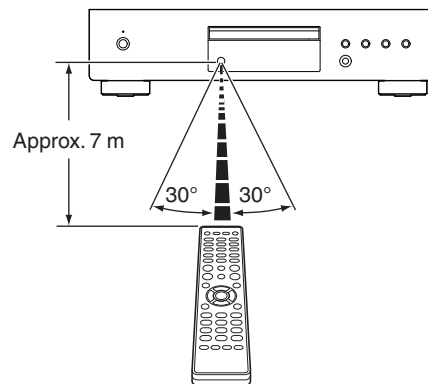

Features

High quality sound

- **AL32 Processing and high precision 32 bit / 192 kHz D/A converter**

Equipped with AL32 Processing, Denon's own analog waveform reproduction technology. The reproducibility of weak signals is enhanced by expanding 16 bit digital data to 32 bit. Additionally, the unit is equipped with a 32 bit/192 kHz-bit compatible high-accuracy D/A converter for converting the digital data expanded by AL32 Processing into analog signals.

High performance

- **Supports MP3 and WMA file playback** (👉 p. 28)

MP3 and WMA files that have been recorded onto CD-R or CD-RW discs can be played back on this CD player.

- **Reduced power consumption during standby**

The power consumption in standby mode has been reduced to below 0.3 W in consideration of the environment.



Part names and functions

Front panel

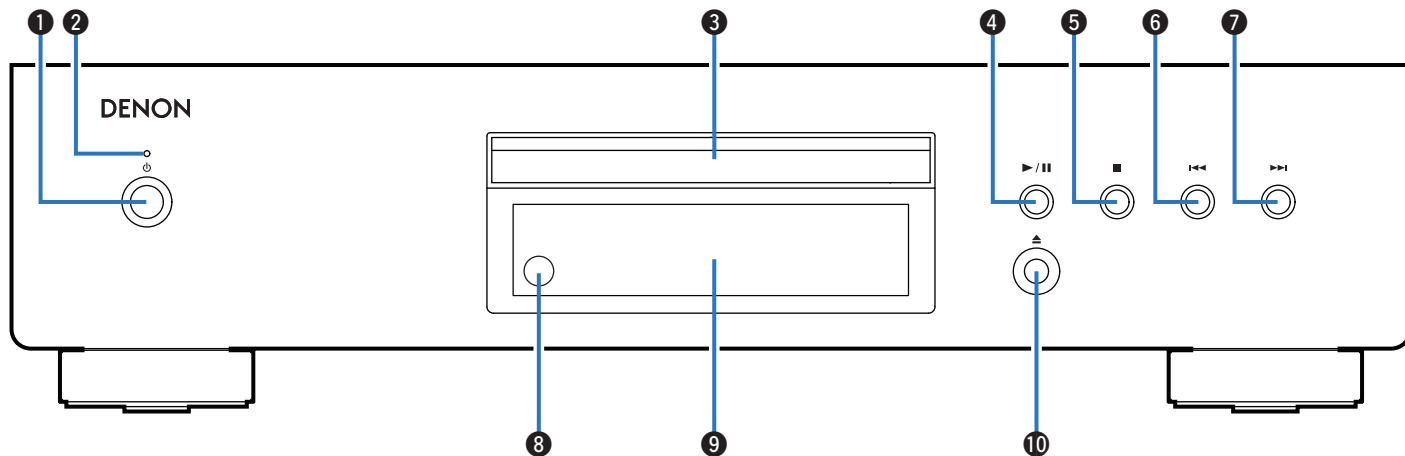

For details, see the next page.



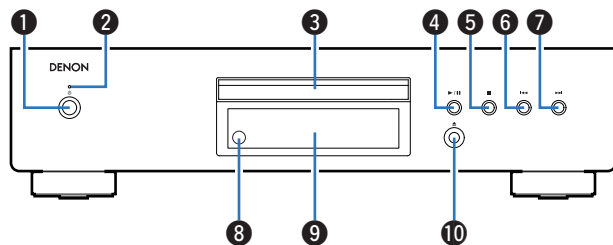

1 Power operation button (⏻)

This turns the power on/off. (☞ p. 23)

2 Power indicator

This is lit as follows according to the power status:

- Power on : Green
- Standby : Off
- Power off : Off

3 Disc tray

Used to insert a disc.

4 Play/pause button (▶/⏸)

Plays the track/Pauses the track.

5 Stop button (■)

Stops playback.

6 Reverse-skip button (◀◀)

Returns to the start of the currently playing track.

7 Forward-skip button (▶▶)

Plays the next track.

8 Remote control sensor

This receives signals from the remote control unit. (☞ p. 5)

9 Display

Various information is displayed here. (☞ p. 9)

10 Disc tray open/close button (⏏)

Used to open/close the disc tray.



Display

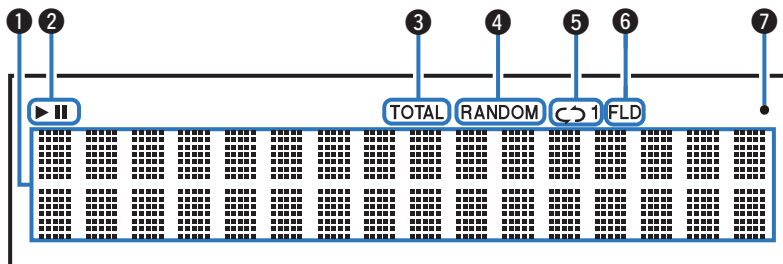

1 Information display

Displays various information or playback elapsed time and so on of the disc.

2 Playback mode indicators

▶ : Lights up during playback.

|| : Lights up during pause.

3 TOTAL indicator

Lights when the total number of tracks and total time of the CD are displayed.

4 RANDOM indicator

Lights during random playback.

5 Repeat mode indicators

Lights to match the repeat mode settings.

6 Folder mode indicator

Lights up when the folder mode is set in the CD-R/CD-RW playback range. (☞ p. 30)

7 Remote control signal reception indicator

Lights when a signal is received from the remote control.



Rear panel

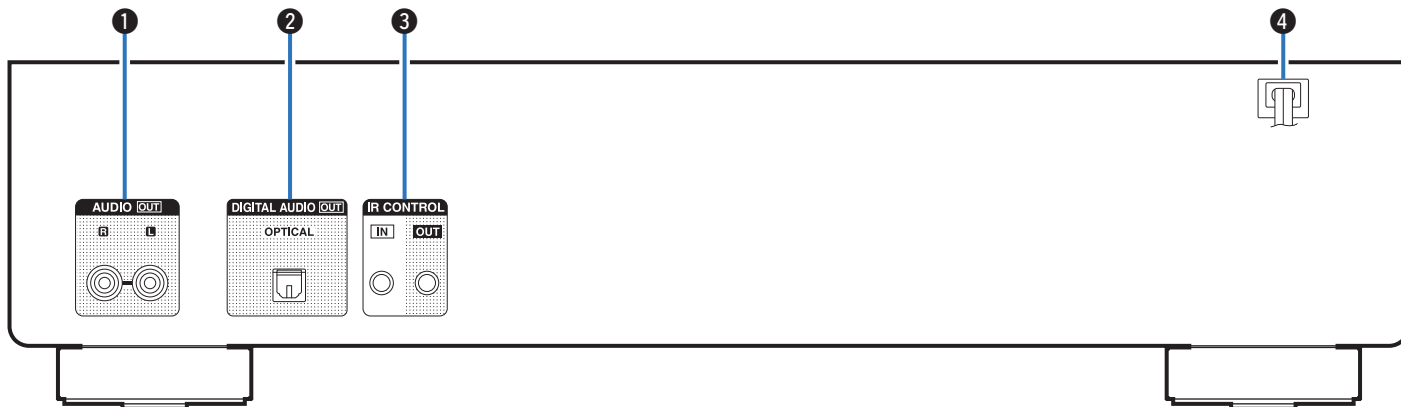

1 AUDIO OUT connectors

Used to connect devices equipped with analog audio inputs connectors or an external power amplifier. (👉 p. 18)

2 DIGITAL AUDIO OUT connector

Used to connect an AV receiver or D/A converter that has a digital input connectors. (👉 p. 19)

3 IR CONTROL connectors

Used to connect Denon network audio players with an IR controller.

4 Power cord (👉 p. 21)



Remote control unit

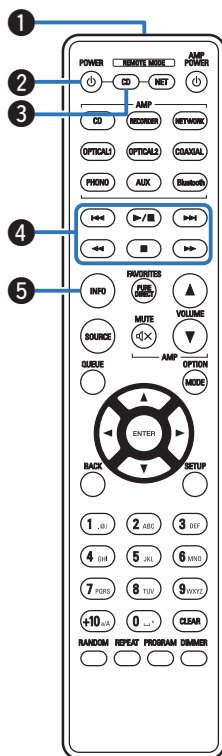

The remote control provided with this unit can control a network audio player in addition to a Denon amplifier.

- “Amplifier operations” (📖 p. 14)
- “Network audio player operations” (📖 p. 15)

■ Operating this unit

To operate CD player, press **REMOTE MODE CD** button to switch the remote control to the CD player operation mode.

1 Remote control signal transmitter

This transmits signals from the remote control unit. (📖 p. 5)

2 Power operation button (POWER ⏻)

This turns the power on/off (standby). (📖 p. 23)

3 Remote mode select button (REMOTE MODE CD)

This switches the remote control operating mode to CD player.

4 System buttons

These perform playback related operations.

5 Information button (INFO)

This switches the track information shown in the display during playback.



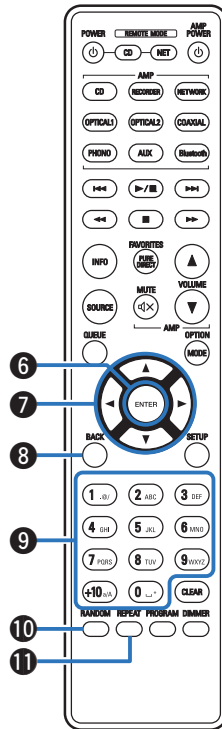

6 ENTER button

This determines the selection.

7 Cursor buttons (Δ ∇ \triangleleft \triangleright)

These select items.

8 BACK button

Returns to the previous item.

9 Number buttons (0 – 9, +10)

These enter letters or numbers into the unit.

10 RANDOM button

Switches the random playback.

11 REPEAT button

Switches to the repeat playback.



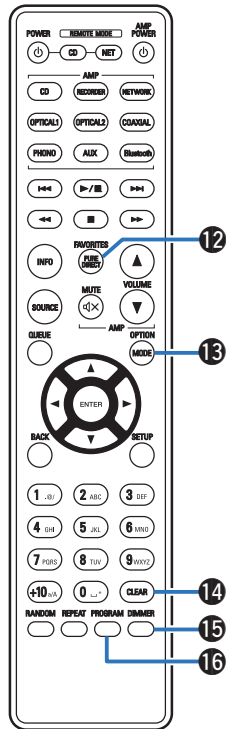

12 PURE DIRECT button

Switches the Pure Direct mode. (👉 p. 24)

13 MODE button

Selects the playback range of the data CD. (👉 p. 30)

14 CLEAR button

This clears the program registration. (👉 p. 27)

15 DIMMER button

This switches the brightness of the display. (👉 p. 24)

16 PROGRAM button

This sets program playback. (👉 p. 27)



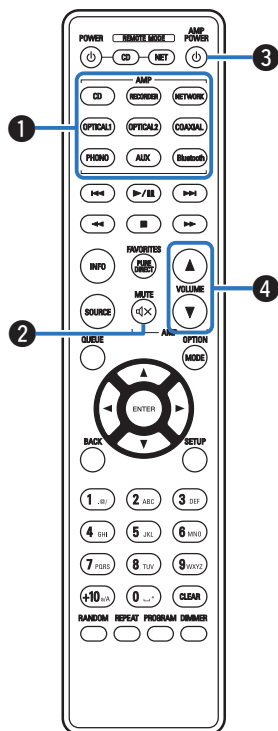

■ Amplifier operations

A Denon amplifier can be operated.

- ① Input source select buttons
- ② MUTE button (🔇)
- ③ Power operation button (AMP POWER ⏻)
- ④ VOLUME buttons (▲▼)



- The remote control may not operate some products.



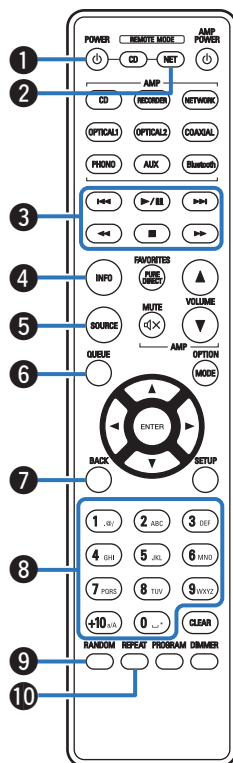

■ Network audio player operations

You can operate a Denon network audio player.

To operate a Denon network audio player, press the REMOTE MODE NET button to switch the remote control to the network audio player operation mode.

- 1** Power operation button (POWER ϕ)
- 2** Remote mode select button (REMOTE MODE NET)
- 3** System buttons
- 4** Information button (INFO)
- 5** SOURCE button
- 6** QUEUE button
- 7** BACK button
- 8** Number/letter buttons (0 – 9, +10)
- 9** RANDOM button
- 10** REPEAT button



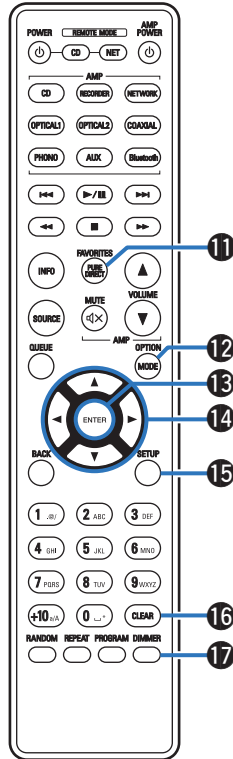

- 11 FAVORITES button
- 12 OPTION button
- 13 ENTER button
- 14 Cursor buttons ($\Delta \nabla \triangleleft \triangleright$)
- 15 SETUP button
- 16 CLEAR button
- 17 DIMMER button



- The remote control may not operate some products.



■ Contents

Connecting an amplifier	18
Connecting to a device with digital audio input connectors	19
Connecting the timer device	20
Connecting the power cord	21

NOTE

- Do not plug in the power cord until all connections have been completed.
- Do not bundle power cords together with connection cables. Doing so can result in humming or noise.

■ Cables used for connections

Provide necessary cables according to the devices you want to connect.

Audio cable
(supplied)



Optical cable



Connecting an amplifier

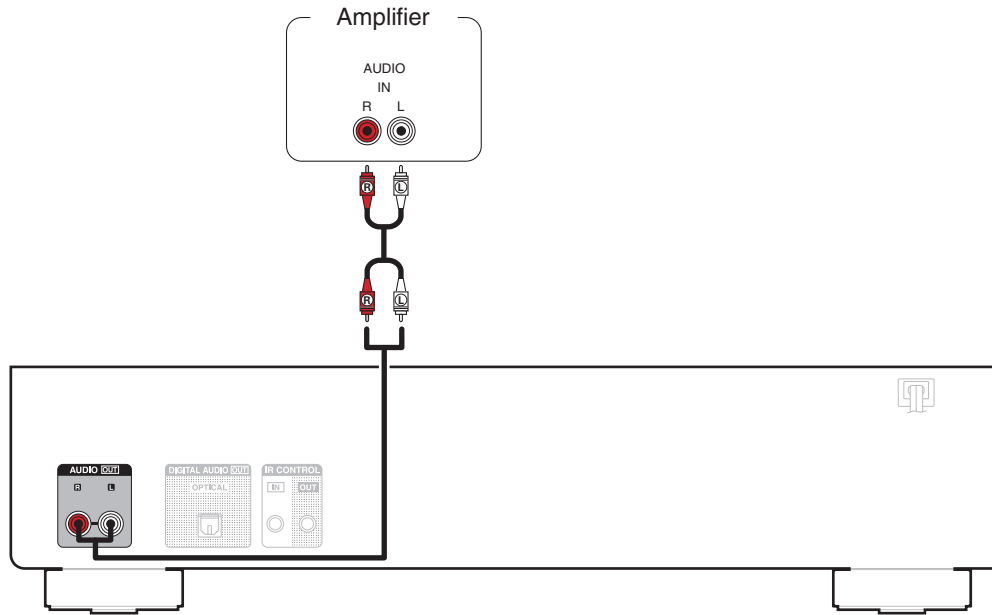

Connecting to a device with digital audio input connectors

You can enjoy digital audio playback by connecting an amplifier or D/A converter that has a digital audio connector to this unit.

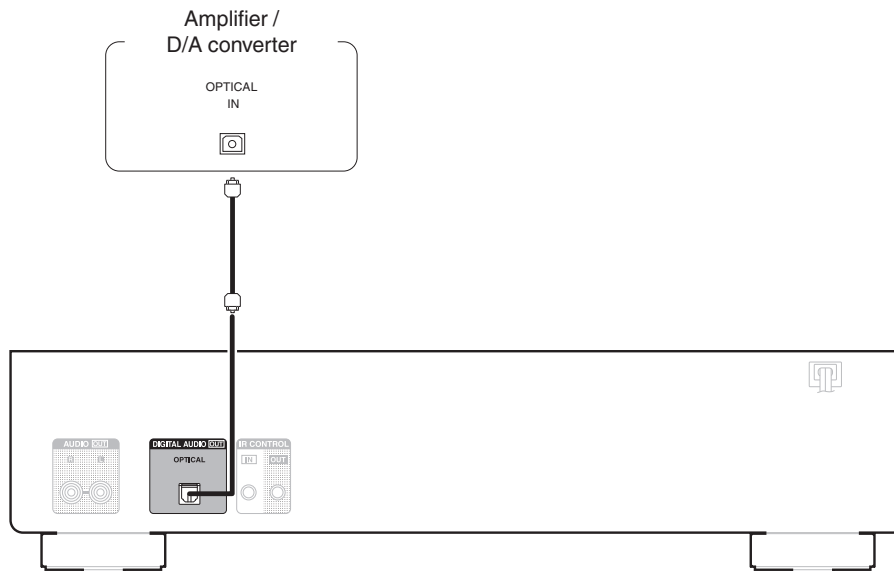

Connecting the timer device

This unit can perform timer play when an amplifier and timer device are connected to this unit. (“Using the timer play function” (👉 p. 31))

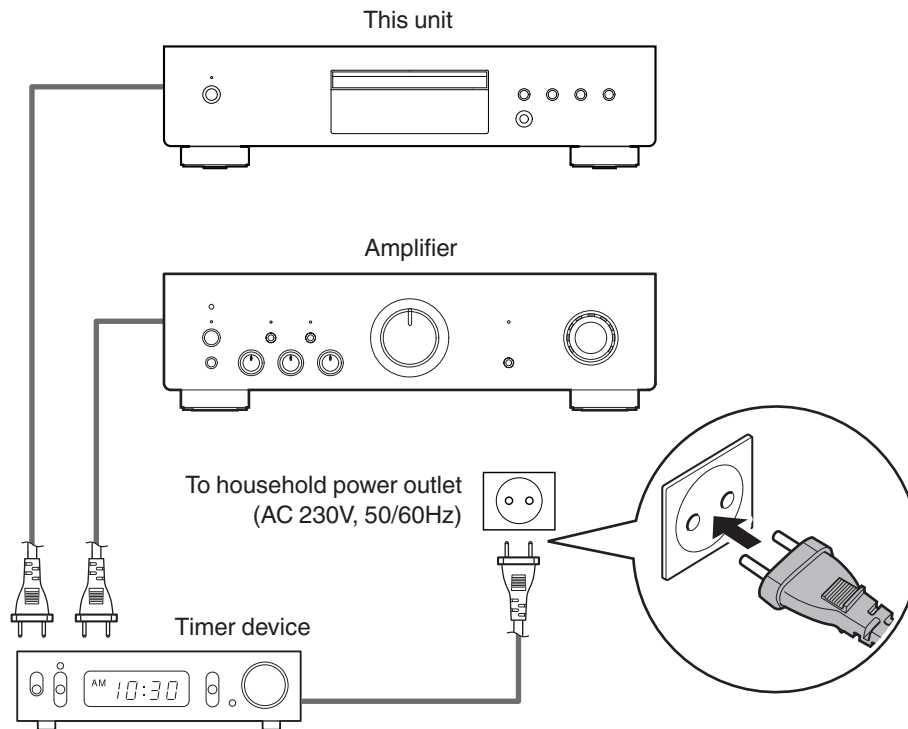

Connecting the power cord

After completing all the connections, insert the power plug into the power outlet.

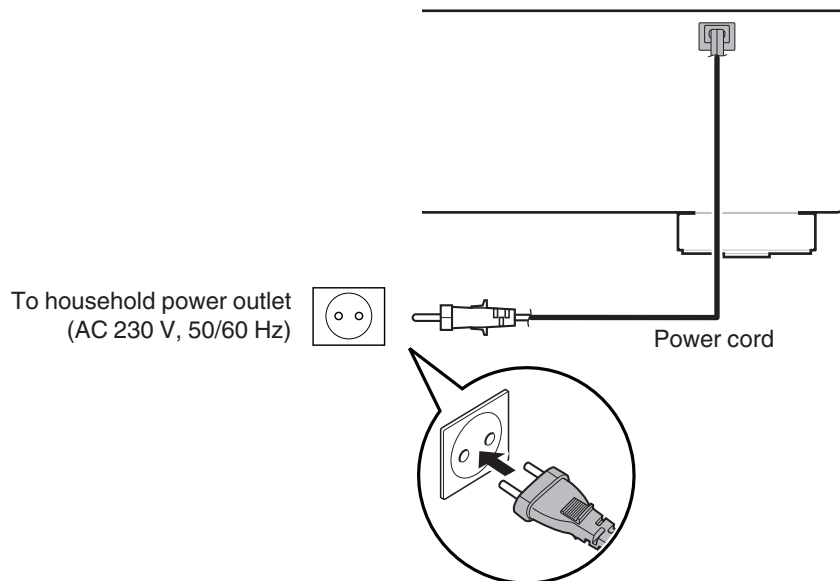

■ Contents

Basic operation	23
Playing CDs	25
Playing DATA CDs	28
Using the timer play function	31



Basic operation

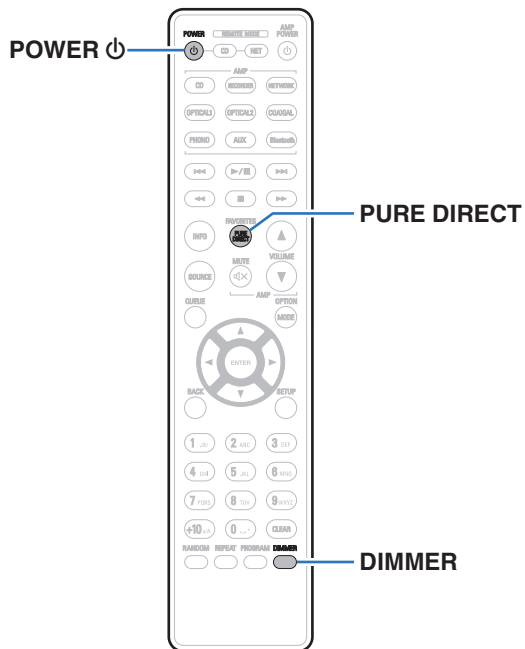

Turning the power on

- 1 Press **⏻** on the main unit to turn the power on.
The power indicator lights green.



- Press POWER **⏻** on the remote control unit to turn on power from standby mode.

Switching the power to standby

- 1 Press **POWER ⏻**.
The unit switches to standby mode.

NOTE

- Power continues to be supplied to some of the circuitry even when the power is in the standby mode. When leaving home for long periods of time or when going on vacation, either press **⏻** on the main unit to turn off the power, or unplug the power cord from the power outlet.



Switching the display's brightness

The display brightness can be adjusted between four levels. Switching the display off reduces a source of noise that affects sound quality, enabling higher sound quality playback.

1 Press DIMMER.

- The brightness of the display switches each time the button is pressed.



- The display brightness is set to most brightly by default.
- Press and hold DIMMER for more than 2 seconds to return the display brightness to the default setting.

Switching the Pure Direct mode

In Pure Direct mode, the display turns off and digital audio output stops. This reduces the source of noise that can adversely affect sound quality, enabling high quality playback.

1 Press PURE DIRECT.

The display turned off, and Pure Direct playback begins.

- Switches the Pure Direct mode each time the button is pressed.

PURE DIRECT ON MODE1:	Turns off the display and outputs digital audio.
PURE DIRECT ON MODE2:	Turns off the display and stops output of digital audio.
PURE DIRECT OFF (Default):	Disables Pure Direct mode.



- The display brightness cannot be changed in Pure Direct mode.
- The display is only turned off during playback.



Playing CDs

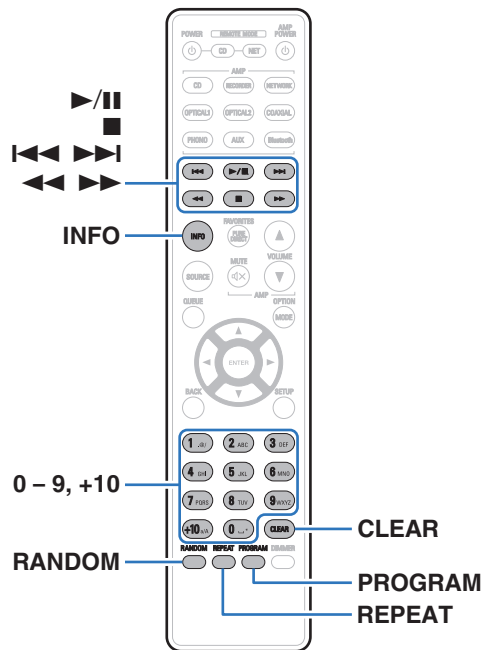





Playing CDs

- 1 Insert a disc. (p. 43)**
 - Press **▶** on the unit to open/close the disc tray.
- 2 Press ▶/||.**
 - The **▶** indicator lights on the display. Playback starts.

NOTE

- Do not place any foreign objects in the disc tray. Doing so could damage the unit.
- Do not push the disc tray in by hand when the power is turned off. Doing so could damage the unit.



Operation buttons	Function
	Playback / Pause
	Stop
	Skip to previous track / Skip to next track
	Fast-reverse / Fast-forward
0 - 9, +10	Select the track
RANDOM	Random playback
REPEAT	Repeat playback <ul style="list-style-type: none"> Switching between All-track repeat, Single-track repeat and Repeat off.
INFO	Time display switching <ul style="list-style-type: none"> Switching between elapsed time of the current track, remaining time of the current track and remaining time of all tracks. The time displayed on this unit may differ from this actual time, as it is calculated by truncating to the nearest 1 second.

■ Discs that can be played back

- See "About Playing Back Discs". (📖 p. 40)

■ Playing a specific track (Direct searching)

1 Use 0 - 9, +10 to select the tracks.

[Example]

Track 4 :

Press number 4 to select track 4.

Track 12 :

Press numbers +10 and 2 consecutively.



Playing tracks in a specific order (Program playback)

Up to 25 tracks can be programmed.

1 In the stop mode, press PROGRAM.

“PGM” appears on the display.

2 Use 0 – 9, +10 to select the tracks.

[Example]

To program tracks 3 and 12 to be played in that order, press 3, +10 and 2 one after the other.

3 Press ►/||.

Playback starts in the programmed order.



- The program is cleared when the disc tray is opened or the power is turned off.
- When RANDOM is pressed during program playback, the programmed tracks are played in random order.
- When REPEAT is pressed during program playback, the tracks are played repeatedly in the programmed order.

■ Checking the order of the programmed tracks

In the stop mode, press ►►I.

The tracks are shown in the programmed order in the display each time ►►I is pressed.

■ To clear the last track programmed

In the stop mode, press CLEAR.

The last track programmed is cleared each time the button is pressed.



- You can also select a track to be cleared by pressing ►►I.

■ Clearing the all programmed track

In the stop mode, press PROGRAM.



Playing DATA CDs

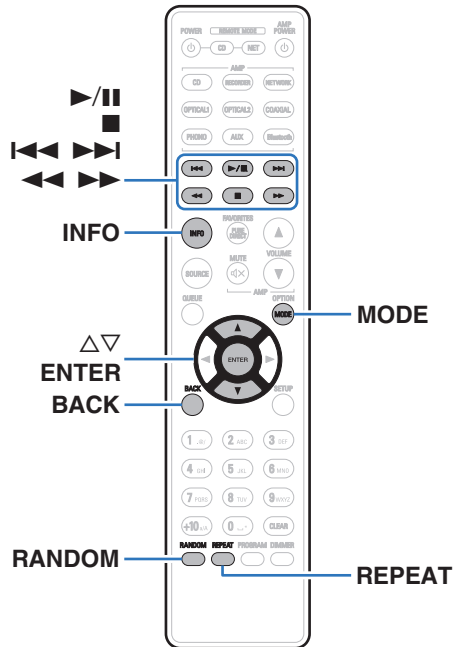

- This section explains how to playback music files that are recorded onto a CD-R or CD-RW.
- There are many music distribution sites on the Internet allowing you to download music files in MP3 or WMA (Windows Media® Audio) format. The music (files) downloaded from such sites can be stored on CD-R/-RW discs and played on this unit.
- The audio format types and specifications supported by this unit for playback are as follows.
See “Playable files” for details. (👉 p. 40)
 - **MP3**
 - **WMA**

NOTE

- Copyright-protected files cannot be played.
Note that depending on the software used for burning and other conditions, some files may not play or display correctly.

“Windows Media” and “Windows” are the trademarks or registered trademarks of Microsoft Corporation in the United States and other countries.







Playing files

1 Load a CD-R/-RW disc containing music files into the disc tray. (🔧 p. 43)

- Press  on the unit to open/close the disc tray.

2 Use $\Delta \nabla$ to select the music file to be played from the CD-R/CD-RW music data, then press ENTER.

Playback starts.

Operation buttons	Function
	Playback / Pause
	Stop
	Skip to previous track / Skip to next track
	Fast-reverse / Fast-forward
BACK	Moving up a level in the folder tree
$\Delta \nabla$	Select the item
ENTER	Enter the selected item / Playback
MODE	Select the playback range
RANDOM	Random playback
REPEAT	Repeat playback <ul style="list-style-type: none"> • Switching between All-track repeat, Single-track repeat and Repeat off.
INFO	Switches the display between Title name / Artist name, Title name / Album name and File name.



- To start playing another file during playback of a CD-R/CD-RW, first press BACK to display the file tree. Next, use $\Delta \nabla$ to select the file to be played and press ENTER.



■ Switching the display

During playback, press INFO.

- Switches the display between Title name / Artist name, Title name / Album name and File name.
- If a file does not support text information or no track information is recorded, the file name is displayed.
- The player can display the following characters:

ABCDEFGHIJKLMNOPQRSTUVWXYZ

abcdefghijklmnopqrstuvwxyz

0123456789

! " # \$ % & ; : < > ? @ \ [] _ ` | { } ~ ^ ' () * + , - . / = space

- Any characters that cannot be displayed are replaced with "." (period).
- The folder and file numbers are set automatically when the disc is loaded.

■ Switching the playback range

In the stop mode, press MODE.

- The playback range of a track can be set.

Folder mode:

All the files in the selected folder are played. The "FLD" indicator on the display lights at this time.

All mode:

All the files in the disc are played.



Using the timer play function

- 1 Turn on the power of the connected components.**
( p. 20)
- 2 Switch the amplifier's function to input from the connected unit.**
- 3 Load a disc.**
- 4 Set the audio timer for the desired times.**
 - Refer also to the owner's manual of the audio timer.
- 5 Turn the timer "On".**
 - The power of the components connected to the timer turns off.
 - When the set time is reached, the power of the different components automatically turns on and playback starts from the first track.



- The timer play does not support the random playback or program playback.



Setting the Auto Standby mode

When Auto Standby mode is set to On, if the unit remains in the stopped state and no operations are performed for approximately 30 minutes, the unit automatically switches to standby mode.

Auto Standby mode is set to on by default.

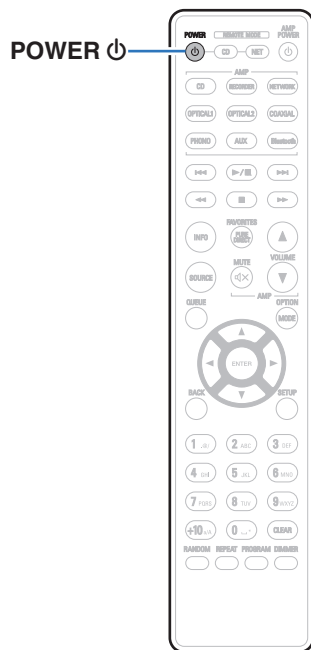

1 Press and hold **POWER** for 5 seconds or more to switch it on and off.

The display changes as follows each time it is switched on and off.

- When auto standby mode is on: "AUTO STANDBY ON" is displayed.
- When auto standby mode is off: "AUTO STANDBY OFF" is displayed.



■ Contents

Tips

I want to enjoy analog output audio at higher quality	34
I want to playback just the specified folder	34
I want to randomly play back all tracks on a CD-R/CD-RW	34

Troubleshooting

Power does not turn on / Power is turned off	36
Operations cannot be performed through the remote control unit	37
Display on this unit shows nothing	37
No sound comes out	38
Sound is interrupted or noise occurs	38
Cannot playback Discs	39



Tips

I want to enjoy analog output audio at higher quality

- Switch pure direct mode to “PURE DIRECT ON MODE2”. (👉 p. 24)

I want to playback just the specified folder

- Press the MODE button to set the playback mode to folder playback mode. (👉 p. 30)

I want to randomly play back all tracks on a CD-R/CD-RW

- Before playback, press the MODE button to set the playback mode to “All Mode”, then press the RANDOM for random playback. (👉 p. 30)



Troubleshooting

If a problem should arise, first check the following:

1. Are the connections correct?
2. Is the set being operated as described in the owner's manual?
3. Are the other devices operating properly?

If this unit does not operate properly, check the corresponding symptoms in this section.

If the symptoms do not match any of those described here, consult your dealer as it could be due to a fault in this unit. In this case, disconnect the power immediately and contact the store where you purchased this unit.



Power does not turn on / Power is turned off

Power is not turned on.

- Check whether the power plug is correctly inserted into the power outlet. (👉 p. 21)
- This unit is in standby mode. Press the POWER ⏻ button on the remote control. (👉 p. 23)

Power automatically turns off.

- The auto standby mode setting is on. The auto standby mode automatically switches the unit to standby if there are no operations for more than 30 minutes. To disable the Auto Standby mode, press and hold the POWER ⏻ button on the remote control for more than 5 seconds when the Auto Standby mode is enabled. (👉 p. 32)

When the power is turned on, the power indicator flashes in red.

- The protection circuit has been activated due to an error in the internal power supply. Press the ⏻ button on the main unit to turn off the power, and then turn on the power again.



Operations cannot be performed through the remote control unit

Operations cannot be performed through the remote control unit.

- Batteries are worn out. Replace with new batteries. (👉 p. 5)
- Operate the remote control unit within a distance of about 7 m from this unit and at an angle of within 30°. (👉 p. 5)
- Remove any obstacle between this unit and the remote control unit.
- Insert the batteries in the proper direction, checking the ⊕ and ⊖ marks. (👉 p. 5)
- The unit's remote control sensor is exposed to strong light (direct sunlight, inverter type fluorescent bulb light, etc.). Move the set to a place in which the remote control sensor will not be exposed to strong light.
- When using a 3D video device, the remote control unit of this unit may not function due to effects of infrared communications between units (such as TV and glasses for 3D viewing). In this case, adjust the direction of units with the 3D communications function and their distance to ensure they do not affect operations from the remote control unit of this unit.

Display on this unit shows nothing

Display is off.

- Press the DIMMER button, and change the setting to anything other than off. (👉 p. 24)
- When Pure Direct mode is set to "PURE DIRECT ON MODE1" or "PURE DIRECT ON MODE2", the display turns off. Press the PURE DIRECT button on the remote control to set "PURE DIRECT OFF". (👉 p. 24)



No sound comes out

No sound is produced. Or sound is distorted.

- Check the connections for all devices. (👉 p. 17)
- Insert connection cables all the way in.
- Check that input connectors and output connectors are not reversely connected.
- Check cables for damage.
- Check the amplifier's functions and controls and adjust as necessary.
- When Pure Direct mode is set to "PURE DIRECT ON MODE2", digital audio output stops. Set Pure Direct mode to "PURE DIRECT OFF" or "PURE DIRECT ON MODE1" to output digital audio. (👉 p. 24)

Sound is interrupted or noise occurs

During playback from the CD-R/CD-RW, sound is occasionally interrupted.

- This may be caused by poor recording conditions, or the disc itself may be of poor quality. Use a correctly recorded disc.



Cannot playback Discs

Cannot playback when the play button is pressed, or cannot correctly play back a specific part of the disc.

- The disc is dirty or scratched. Either clean the disc, or insert a different disc. (👉 p. 44)

Cannot playback CD-R/CD-RW.

- Discs cannot be played back unless they have been finalized. Use a finalized disc. (👉 p. 40)
- This may be caused by poor recording conditions, or the disc itself may be of poor quality. Use a correctly recorded disc.
- Files are created in a format that is not supported by this unit. Check the formats supported by this unit. (👉 p. 40)

“NO DISC” is displayed.

- “NO DISC” is displayed if the disc is loaded upside-down or if no disc is loaded.

“SYSTEM ERROR” is displayed.

- “SYSTEM ERROR” is displayed when an error not caused by disc, format, etc., occurs.

“CAN'T READ DISC” is displayed.



- “CAN'T READ DISC” is displayed when the inserted disc cannot be read because it is not compatible with this unit or is dirty or scratched.

“WRONG FORMAT” is displayed.

- “WRONG FORMAT” is displayed for files created in a format that is not supported by this unit. Check the formats supported by this unit. (👉 p. 40)



Playing back Discs

Playable media	
CD	
CD-R	
CD-RW	

NOTE

- Some discs and some recording formats cannot be played.
- Non-finalized discs cannot be played.

Files

■ Specifications of supported files

	Sampling frequency	Bit rate	Extension
MP3	32/44.1/48 kHz	48 – 320 kbps	.mp3
WMA	32/44.1/48 kHz	48 – 320 kbps	.wma

■ Maximum number of playable files and folders

Maximum number of folders : 256

Total number of folders and files : 512



NOTE

- Be sure to give files the extension. Files with any other extensions or files with no extensions cannot be played.
- Recordings you have made should only be used for your personal enjoyment, and as per copyright laws may not be used in other ways without permission of the copyright holder.



- Only music files that are not copyright-protected can be played on this unit.
 - Content downloaded from pay sites on the Internet are copyright protected. Also, files encoded in WMA format when ripped from a CD, etc. on a computer may be copyright protected, depending on the computer's settings.
- The maximum number of files and folders that can be played differs depending on conditions such as the length of the file name or folder name or the number of levels in the folder hierarchy.



Playback order of files

When there are multiple folders containing music files, the playback order of folders is automatically set when this unit reads the media. Files in each folder are played in alphabetical order of file name.

CD-R/CD-RW

For playback of files on CD-R or CD-RW, files are played in order of layer, starting with all folders on the first layer, then the second layer, then the third layer, and so on.



- The playback order displayed on a PC may differ from the actual playback order.
- The playback order with a CD-R/CD-RW may differ, depending on the writing software.

About folders and files

Music files recorded on CD-R/CD-RW are divided into large segments (folders) and small segments (files).

Files are stored in folders, and folders can be placed for storage in a hierarchy. The unit can recognize up to 8 levels of folders.

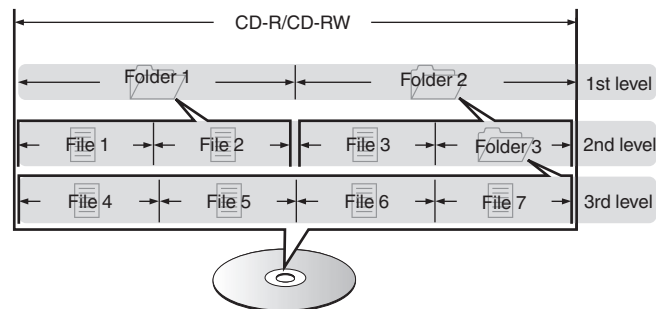

- When writing music files on a CD-R/CD-RW disc, set the writing software's format to "ISO9660". The files may not play properly if they are recorded in other formats. For details, refer to the instructions of your writing software.



Cautions on using media

Loading discs

- Set the disc in the tray label side up.
- Make sure the disc tray is fully open when inserting the disc.
- Place the discs flatly, 12 cm discs in the outer tray guide (Figure 1), 8 cm discs in the inner tray guide (Figure 2).

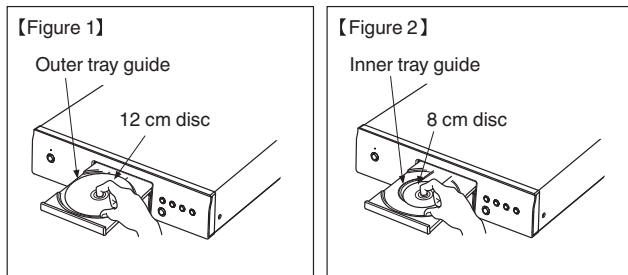

- Place 8 cm discs in the inner tray guide without using an adapter.

NOTE

- Only load one disc at a time. Loading two or more discs can damage the unit or scratch the discs.
- Do not use cracked or warped discs or discs that have been repaired with adhesive, etc.
- Do not use discs on which the sticky part of cellophane tape or labels is exposed or on which there are traces of where labels have been removed. Such discs can get caught inside the player and damage it.
- Do not use discs in special shapes, as they may damage the unit.



- Do not push the disc tray in by hand when the power is off. Doing so could damage the unit.
- If the unit is left in a room full of smoke from cigarettes, etc., for long periods of time, the surface of the optical pickup may get dirty, preventing it from receiving signals properly.



How to handle media

- Do not get fingerprints, oil or dirt on discs.
- Take special care not to scratch discs when removing them from their cases.
- Do not bend or heat discs.
- Do not enlarge the hole in the center.
- Do not write on the labeled (printed) surface with ball-point pens, pencils, etc., or stick new labels on discs.
- Condensation may form on discs if they are moved suddenly from a cold place (outdoors for example) to a warm place, but do not try to dry discs with a hairdryer, etc.
- Do not store discs in the following places:
 1. Places exposed to direct sunlight for long periods of time
 2. Dusty or humid places
 3. Places exposed to heat from heaters, etc.

Cleaning discs

- If there are fingerprints or dirt on a disc, wipe them off before using the disc.
- Use a commercially available disc cleaning set or a soft cloth to clean discs.



Gently wipe the disc from the inside towards the outside.

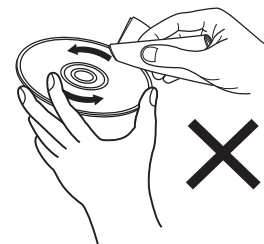

Do not wipe with a circular motion.

NOTE

- Do not use record spray, antistatic agents, benzene, thinner or other solvents.

Explanation of terms

AL32 Processing

Equipped with AL32 Processing, Denon's own analog waveform reproduction technology. The reproducibility of weak signals is enhanced by expanding 16 bit digital data to 32 bit.

MP3 (MPEG Audio Layer-3)

This is an internationally standardized audio data compression scheme, using the "MPEG-1" video compression standard. It compresses the data volume to about one eleventh its original size while maintaining sound quality equivalent to a music CD.

WMA (Windows Media Audio)

This is audio compression technology developed by Microsoft Corporation.

WMA data can be encoded using Windows Media® Player.

To encode WMA files, only use applications authorized by Microsoft Corporation. If you use an unauthorized application, the file may not work properly.

Sampling frequency

Sampling involves taking a reading of a sound wave (analog signal) at regular intervals and expressing the height of the wave at each reading in digitized format (producing a digital signal).

The number of readings taken in one second is called the "sampling frequency". The larger the value, the closer the reproduced sound is to the original.

Dynamic range

The difference between the maximum undistorted sound level and the minimum discernible level above the noise emitted by the device.

Bit rate

This is the amount of audio data recorded on a disc that is read in one second.

Finalizing

This process enables DVD/CD recorded with a recorder to be played by other players.

Linear PCM

This is an uncompressed PCM (Pulse Code Modulation) signal. Unlike lossy compression audio sources such as MP3, no audio quality or dynamic range deteriorates.



Trademark information



Adobe, the Adobe logo and Reader are either registered trademarks or trademarks of Adobe Systems Incorporated in the United States and/or other countries.



Specifications

■ Audio section

- Analog output

Channels:	2-channel
Playable frequency range:	2 Hz – 20 kHz (sampling frequency: 44.1 kHz)
Playable frequency response:	2 Hz – 20 kHz (sampling frequency: 44.1 kHz)
S/N:	112 dB
Dynamic range:	101 dB
Harmonic distortion:	0.003 %
Output level:	2.0 V RMS



- **Optical readout system**

Laser:	AlGaAs
Wave length:	780 nm
Signal type:	16-bit linear PCM
Sampling frequency:	44.1 kHz

- **Digital output**

Optical :	-15 – -21 dBm
------------------	---------------

■ General

Operating temperature:	+5 °C - +35 °C
Power supply:	AC 230 V, 50/60 Hz
Power consumption:	12 W
Power consumption in standby mode:	0.3 W

For the purpose of improvement, the specifications and design are subject to change without notice.





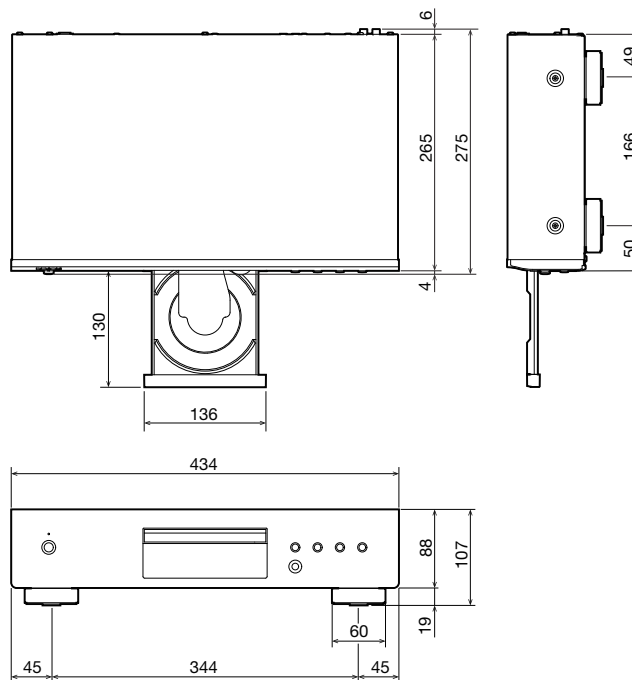



■ Dimensions (Unit : mm)



■ Weight : 4.3 kg

Index

 A	
Amplifier	18, 19
Auto Standby	32
 C	
CD	25
 D	
D/A converter	19
DATA CD	28
Display	9
Display's brightness	24
 F	
Front panel	7
 P	
Program playback	27
 R	
Rear panel	10
Remote control unit	11
 T	
Timer device	20, 31
Tips	34
Troubleshooting	35



DENON®

www.denon.com

3520 10694 00AD

Copyright © 2019 D&M Holdings Inc. All Rights Reserved.